



Team GRANIT

Green Radio and Adaptive Nodes for the Internet of Things

Lannion

Activity Report

2021

1 Team

Name	Forename	Position
BERDER	Olivier	Full Professor, UR1 (IUT Lannion)
CARQUIN	Émilie	Research Assistant, UR1 (ENSSAT Lannion)
COURTAY	Antoine	Associate Professor, UR1 (ENSSAT Lannion)
GAUTIER	Matthieu	Associate Professor (HDR), UR1 (IUT Lannion)
GERZAGUET	Robin	Associate Professor, UR1 (ENSSAT Lannion)
ROCHER	Romuald	Associate Professor, UR1 (IUT Lannion)
SCALART	Pascal	Full Professor, UR1 (ENSSAT Lannion)
THÉPAULT	Joëlle	Research Assistant, UR1 (ENSSAT Lannion)
VRIGNEAU	Baptiste	Associate Professor, UR1 (IUT Lannion)

Table 1: GRANIT permanent members

The GRANIT team comprises 7 permanent research members: 2 full professors (*Professeur des Universités*) and 5 associate professors (*Maître de conférences*). There are currently 7 PhD students in the GRANIT team. Table 1 lists the permanent staff and table 2 the current PhD students and other staff.

Name	Forename	Status	Period
DJIDI	Nour el hoda	PhD	10/2018 - 12/2021
LACROIX	Marie-Anne	PhD	Since 10/2018
LAVAUD	Corentin	PhD	Since 10/2018
COURJAULT	Jules	PhD	Since 06/2020
EL RHAZ	Samir	PhD	Since 10/2020
ARGOTE AGUILAR	Jesus	PhD	Since 10/2021
CHILLET	Alice	PhD	Since 10/2021
EL BOUCHIKHI	Fatima	PhD	Since 10/2021
CARESMEL	Clément	Research Engineer	Since 03/2019
LE GENTIL	Mickaël	Research Engineer ⁺	09/2016 - 08/2021
MABON	Malo	Research Engineer	Since 01/2018

Table 2: GRANIT other staff

2 Overall Objectives

2.1 Overview

General purpose wireless devices as smartphones already have to carry more and more data while keeping their autonomy as long as possible, but the next challenge they will face is the ubiquity of users. This ability to be connected everywhere in a continuous and transparent way, keeping the same quality of services (QoS) whatever the environment, implies that devices can deal with different wireless standards, furthermore choosing for each of them the most energy efficient configuration. In this connected world, even the smallest sensors will be able to send their data over what is called Internet of Things (IoT), such that every user in the world could reach it. The problem that designers will face is then the autonomy of such sensors, since radio is very energy consuming, and obviously, the more sensors we place, the less we want to change batteries.

Energy autonomous Communications

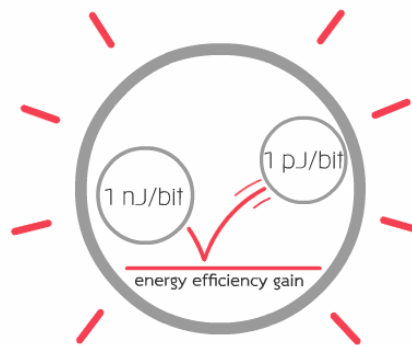

Figure 1: Transmission Energy efficiency target for the next decade

In such a context, the GRANIT team purpose is to design algorithms and architectures able to adapt to environment parameters, such as propagation channel characteristics, wireless traffic conditions network topology or possibilities of energy harvesting, while respecting applications requirements in terms of data rate, reliability, latency, and most of all, life time of involved systems, etc. As represented by Fig. 1, the quantitative target of GRANIT over the next ten years is to decrease the energy of radio transmission by several orders of magnitude to reach 1 pJ per bit. The GRANIT members have a strong experience on wireless sensor network (WSN) protocols (MAC and PHY layers) and hardware architectures, and developed several WSN platforms and demonstrators for various areas monitoring applications or dedicated to human body. As energy can now be scavenged from the direct environment of sensor nodes (light, heat, vibrations, etc.), a harvesting board can be added to WSN platforms. One of the objectives of the GRANIT team is then to design power management strategies, coupled to above-mentioned adaptive algorithms in order to reach real energy autonomy of the sensor nodes. Cooperation between nodes, either through distributed computing to find the best radio/computation trade-off or through the choice of the best cooperative relaying

schemes, represents also a key challenge for the design of energy-efficient wireless systems. The GRANIT team will continue to investigate this very promising field at both physical and medium access layers. Last but not least, the aim of GRANIT team is also to efficiently implement these algorithms onto different targets, from low power microcontrollers and/or low power FPGAs for WSN solutions to powerful system-on-chip and multi-core systems for more computing-intensive applications. To answer the demand of agile devices, software defined radio solutions (SDR) will especially be considered, not only for high data-rate mobile standards such as 5G, but also for wireless sensor networks, enabling testbeds for low power adaptive and/or cooperative solutions.

2.2 Key Issues

Wireless communications represent obviously the major domain of applications for the adaptive algorithms and/or architectures proposed by the GRANIT team. The range of devices that fall within this denomination is however very large, and our developments will mainly address two different targets, namely next generations of wireless systems (5G, beyond 5G...) and wireless sensor networks. In addition to analytical derivations and simulations, the GRANIT team clearly aims at using platforms to evaluate our research performance, but also to reach what could be called a platform-based design, meaning that the constraints of the envisaged platforms are taken into account very soon in the design process. Upon this basis, the research topics of the GRANIT team can be represented as Figure 2.

Focusing on the baseband processing of the physical layer, two main issues are raised by the new requirements of wireless communications: (i) What are the signal processing techniques that could help improving the link quality, the spectrum usage and the energy efficiency? (ii) What kind of hardware could associate energy efficiency and high-performance computing of these signal processing techniques? A huge effort is currently spent on proposing new physical layers and many digital communication techniques have been widely studied.

Taking into account the specificities of the targets envisaged for the adaptive algorithms, we will adapt the latter to design very energy-efficient wireless transmissions. To a certain degree, we claim that software-based systems will provide the flexibility to adapt to new requirements and make it easier to introduce innovation in the architecture¹. Thus, our proposal relies on high-level synthesis (HLS) in order to bridge the gap between high-level specifications and hardware implementation². Depending on the hardware target, hardware/software partitioning, reconfiguration capability or power management will be included in the design flow.

The objective of GRANIT members is mainly twofold, firstly confirm their expertise on IoT core technologies while exploring further the possibility to implement as close as possible application algorithms on hardware targets, secondly to take profit of heterogeneity of emerging software radio solutions to define new partitioning methodologies and address security and of course energy issues. As illustrated by Fig. 2, energy efficiency remains the principal concern

¹J.F. Jondral, Software-defined radio: basics and evolution to cognitive radio. *EURASIP J. Wireless Commun. Netw.*, 2005, pp. 275-283

²P. Coussey, D. Gajski, M. Meredith, A. Takach, An Introduction to High-Level Synthesis, *IEEE Design & Test of Computers*, 26 (4): 8-17, 2009

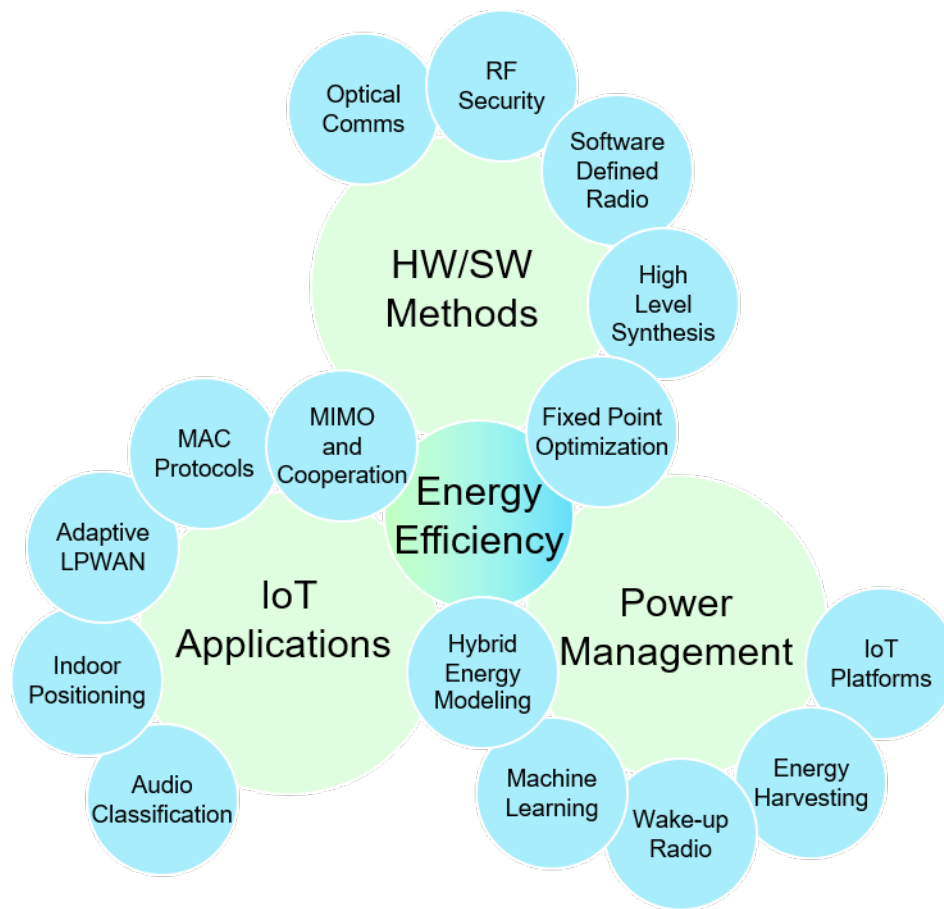

Figure 2: GRANIT Research Topics

of the team, and will be the common denominator of most of the envisioned research. This concern will feed three main topics, namely Power management, Hardware/Software (HW/SW) methods and IoT Applications. Albeit being different and complementary, the intersection between them is far from null and most of the conducted researches will be of course related to several topics.

3 Scientific Foundations

3.1 Positioning in Architecture Department of IRISA

GRANIT belongs to D3 department of IRISA dedicated to Architecture and takes place besides PACAP and TARAN teams. While these latter teams aim to design new architectures and associated compiling tools, the approach of GRANIT is more user or application-centric, i.e. our research will mostly rely on existing hardware components (even though some specific designs will still be achieved) and take into account the constraints that they incur to develop efficient algorithms. This interaction between architecture and algorithms is explored from

both angles of adaptivity and cooperation.

3.2 Power management

One of the purposes of the GRANIT team is to consider algorithmic-level optimizations for energy savings. More precisely, the relationship between computation and communication will be studied from the energy point of view, in order to enable dynamic energy management. Reducing power due to radio communications can be achieved by two complementary main objectives: (i) to minimize the output transmit power while maintaining sufficient wireless link quality and (ii) to minimize useless wake-up and channel hearing while still being reactive. For this purpose, this project aims at defining and implementing new power-aware techniques that can dynamically adapt at run-time:

- the chosen algorithms of the radio physical layer (e.g. modulation, spreading, bit-rate, cooperative strategies, etc.),
- the wake-up interval of the MAC protocol,
- the accuracy (bit-width) of signal processing algorithms,
- the transmit power,

depending on some parameters such as:

- radio channel conditions,
- quality-of-service (QoS) required by the application,
- harvested energy,
- topology of the networks.

The global framework of such an optimization can be represented as in Figure 3.

The first research topic therefore directly concerns power management strategies, which aims either at decreasing as much as possible the energy consumption of wireless systems (thus increasing the latter lifetime) or at using available energy as good as possible in case of energy harvesting. GRANIT team has acquired a renowned expertise in the latter case and proposed many power managers, first for periodic sources and recently for model-free cases. However, there are still many approaches to explore to propose new energy management strategies. The first step is to elaborate accurate models, using both experiments and benchmarks to feed analytical derivations, leading to what we call Hybrid Energy Modelling. If the methodology is quite generic, the obtained model relies on the IoT technology itself, which needs a strong expertise on IoT standards and platforms. The design of the latter is one of the specificities of GRANIT since the team has designed several IoT platforms with or without energy harvesting capabilities, and we really want to continue to go until this hardware design and/or integration step to validate all our algorithms. It has to be mentioned that thanks to industrial collaborations and collaborative projects, GRANIT has benefited for five years from

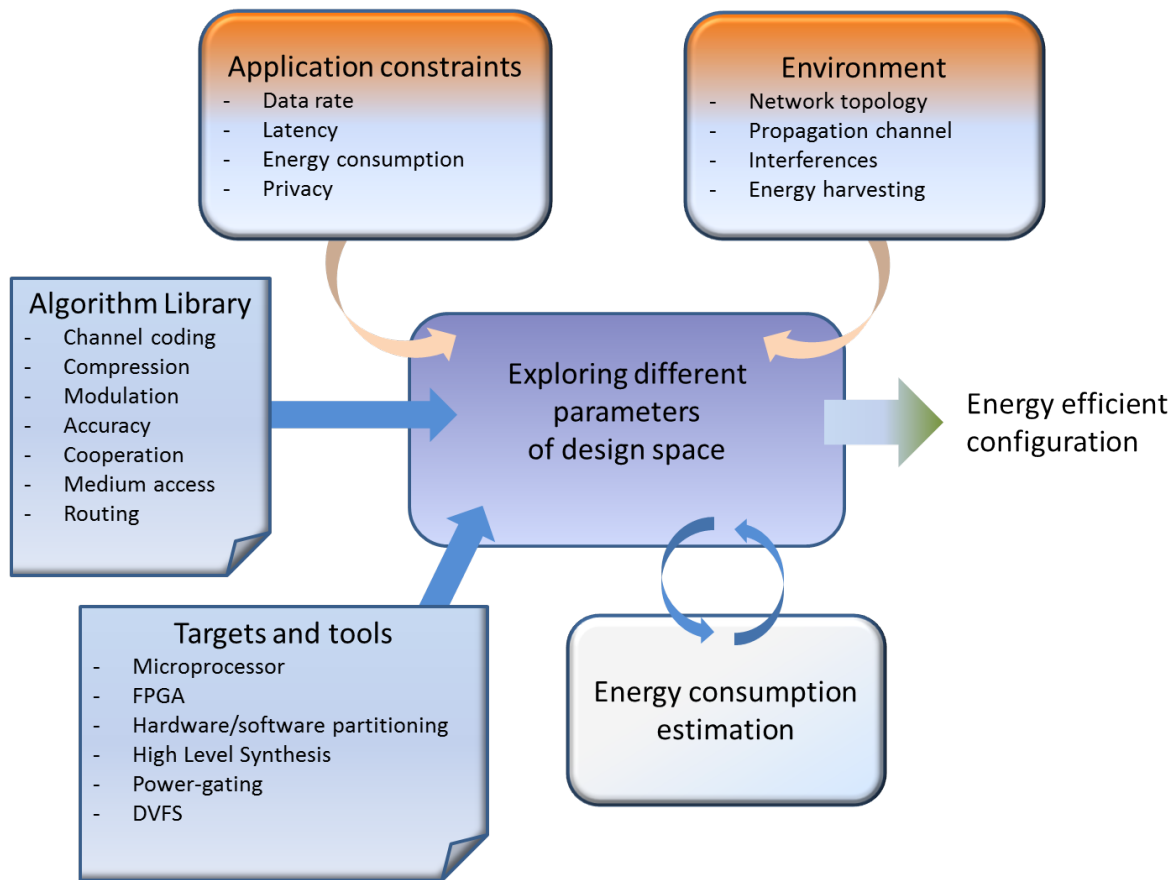

Figure 3: GRANIT Optimization Methodology

the support of several engineers that help researchers to maintain and design the platforms. This development team is shared with TARAN team, is composed of four engineers in average, and is an asset for both teams that we absolutely want to preserve. The recent development of energy efficient wake-up radios makes possible the continuous listening of wireless channels, decreasing simultaneously energy consumption and latency. But all existing wake-up radios are very application-specific and are not able to adapt themselves and find the best trade-off between energy consumption, range and latency in case of varying conditions. One of the directions we want to explore is to design smart and adaptive wake-up radios at both hardware and software levels, e.g. using light channel coding, soft decoding of addresses, adaptive preamble lengths... Finally yet importantly, it is not possible to avoid the investigation of machine learning for energy management. In previous works, we have shown the efficiency of reinforcement learning for energy harvesting nodes, but this has to be confirmed in industrial deployments with severe constraints. Machine learning is also very promising to help to adapt parameters at both physical layer (modulation, coding, spreading) and access layer (power allocation, wake-up interval...), but the overhead of such an optimization framework has to be carefully studied.

Energy harvesting Advancements in renewable energy sources, such as solar, thermal or wind, are increasing the attention in autonomous Wireless Sensor Networks (WSN). Everlasting energy harvesting allows long-term operations of wireless nodes, which can extremely reduce the cost of battery charging or replacement. Moreover, it has opened a new paradigm for designing Power Managers in self-powered autonomous nodes. Instead of minimizing the consumed energy to maximize the system lifetime as in battery-powered nodes, the PM dynamically adapts the consumed energy according to the fluctuations of the harvested energy, leading to Energy Neutral Operation (ENO)³.

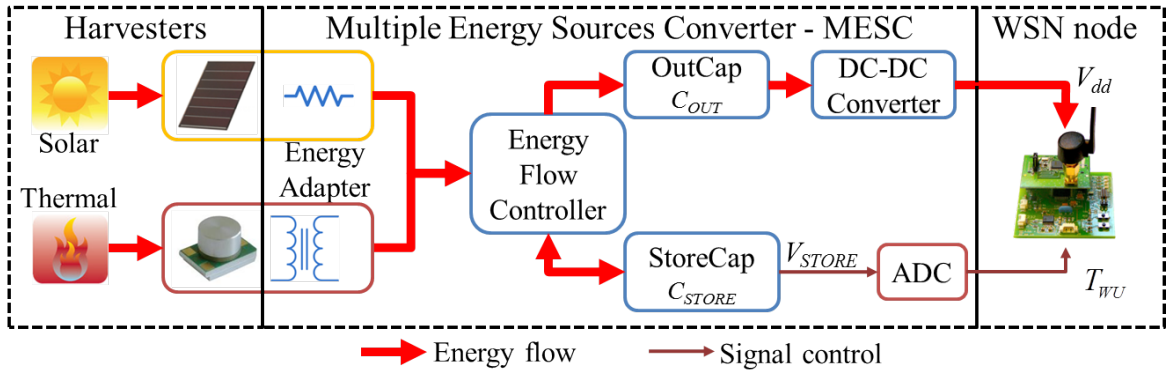

Figure 4: GRANIT Hardware Architecture of our Energy Harvesting Nodes

The GRANIT team activities in EH-WSN aim at designing and implementing new PM (Fig. 4) able to deal with the environment constraints and ensure ENO by tuning sensing, processing and communication parameters.

Wake-up radio Recently, a new consolidated technology that helps to achieve the trade-off between power consumption and latency has appeared. This technology is called Wake-up Radio (WuR). WuR is a secondary Ultra Low Power (ULP) radio subsystem that is connected to the main node. The WuR can be always on or duty cycled and its power consumption is several orders of magnitude less than that of the main node. The WuR is continuously or periodically listening to the channel while the main radio is in sleep mode, and when a specific signal called Wake-Up Beacon (WUB) is received, the WuR wakes up the main radio through an interrupt. Indeed, the WuR allows an asynchronous wake-up of the main node with a low latency. Recent circuit designs of WuR embed a decoding capability through a ULP-MCU or a correlator allowing to wake up only a specific node, thus reducing considerably the waste of energy consumption of the main radio. The fact that the WuR has an ultra low power consumption imposes hardware constraints to keep it simple. Consequently, in addition to a small bit-rate, the WuR has a low sensitivity, which induces a range mismatch between the WuR (short range in the order of 20m) and the main radio (in the order of 100m in case

³A. Kansal, J. Hsu, S. Zahedi, and M. B. Srivastava, Power management in energy harvesting sensor networks, *ACM Trans. Embed. Comput. Syst.*, vol. 6, no. 4, Sep. 2007

of IEEE 802.15.4). Furthermore, the robustness of the WuR presents also a bottleneck, it is very sensitive and therefore subject to noise perturbations, inducing false wake-up. Taking profit of the micro-controller embedded in the WuR (or further hardware modifications, e.g. external ADC), GRANIT team will explore various possibilities to make the WuR smarter. Furthermore, novel MAC protocols leveraging a heterogeneous network architecture composed of both long-range and ultra low power short-range WuRs have to be envisioned.

3.3 Hardware/Software methods

The second topic aims at defining tools and methodologies for efficient implementation of digital communications and signal processing algorithms. Most of emerging processing platforms, even those dedicated to low power applications for IoT, are indeed heterogeneous and composed of several processing units, that can be either dedicated to some resource hungry processing, fully or partly reconfigurable or general purpose. However, very few methodologies exist yet to take profit of this heterogeneity and efficiently partition processing over hardware or software resources. One key leveraging point is to have a unified methodology that can address different architectures with the same formalism (and the same programming language). Classic approaches are often based on low level languages (typically C or C++) to have efficient machine code at the price of the flexibility and the code concision. This is not always desirable due to the complexity of some algorithms (as most of machine learning frameworks). On the other hand, high level language (such as Python) offers a very appealing flexibility at the price of the performance... which often leads to the necessity to recode low level software processing blocks. GRANIT members will pay a particular attention to Julia [BEKS17], a scientific computing language that allows concise code description (e.g. fast prototyping) with high performance (just in time (JIT) compilation using LLVM [LA04]). This methodology should be particularly suited to Software-defined radios (SDR), which have been gaining interest in the last decades. SDR is radio communication system where components that have been traditionally implemented in hardware (e.g. mixers, filters, amplifiers, modulators/demodulators, detectors, etc.) are instead implemented by means of software on a personal computer or embedded system. Some recent designs are even so small and restrained in energy that they become an appealing target for IoT applications [CLK+16], widening the initial scope of SDR applications. GRANIT, with its broadened expertise on IoT standards will be an active actor on light SDR for IoT.

Software Defined Radio Software Defined Radio (SDR) is a flexible signal processing architecture with reconfiguration capabilities that can adapt itself to various air-interfaces. It was first introduced by ⁴ as an underlying structure for Cognitive Radio (CR). The FPGA (Field Programmable Gate Array) technology is expected to play a key role in the development of Software Defined Radio (SDR) platforms. FPGA-based SDR is a quite old paradigm and we are fronting this challenge while leveraging the nascent High Level Synthesis tools and languages. Actually, our goal is to propose methods and tools for rapid implementation of new waveforms in the stringent flexibility paradigm. We propose a novel design flow for

⁴Joseph Mitola J. Mitola III and G. Q. Maguire, Jr., Cognitive radio: making software radios more personal, *IEEE Personal Communications Magazine*, vol. 6, nr. 4, pp. 13-18, Aug. 1999

FPGA-based SDR applications. This flow relies upon HLS principles and its entry point is a Domain-Specific Language (DSL) which partly handles the complexity of programming an FPGA and integrates SDR features. Our studies include :

- defining a Domain-Specific Language for high-level descriptions of radio waveforms,
- generating hardware description (RTL) through the automatic synthesis of the DSL,
- including design constraints in the description through Design Space Exploration of the architecture,
- allowing Dynamic Partial Reconfiguration in the design process,
- validating the design flow from testbed with developments on the GRANIT platforms for multiple standards.

RF Security Information systems are now massively integrated into both industry and administration processes. Thus, their security is matter of importance especially when considering the storing and exchange of sensitive data. Sensitive data is also called 'red' data, in opposition with the non-sensitive (or protected by encryption) 'black' data. This crucial challenge is present at multiple scales, and leads to the emergence of different security fields linked to data protection (defense protocols) and to data interception (attack protocols)

Since few years, a new threat has emerged with the detection of the red data due to unwanted phenomena. This attack is done trough an over the air interception and thus is difficult to detect. These kind of attacks (called TEMPEST attacks by the NSA) consist in detecting an hidden channel that bear the sensitive information and then decode the 'red' information . This unwanted channel may exist due to different physical phenomena such as electro-magnetic coupling, radio frequency leakages, or mechanical mechanisms.

In GRANIT team we have a strong interest on these kinds of thread among two main axis:

- We make thorough analysis on some potential security beaches on existing standards (Bluetooth, Zigbee...) and boards (System On Chips)
- We also conduct studies and analysis on how Software Defined Radio (SDRs) can increase the criticality of TEMPEST attacks making discrete, compact, long range interception devices handy. On this particular aspects, efficient use of SDR is of importance due the large bandwidths and the harsh real time constraints encountered.

3.4 IoT applications

Some applications, as smart cities, connected farms or wildlife monitoring require transmission of data over long distances at a reasonable energy cost. Emerging standards known as Low Power Wide Area Networks (LP-WAN) respect these requirements by proposing trade-offs between transmission range, data rate, and energy consumption. Most of them are tunable through modulation or coding parameters, such as LoRa, and GRANIT team has acquired a highly recognized expertise on LPWAN adaptation to device environment (propagation, interference, energy harvesting...). However severe propagation constraints have still to be

explored, for example for factories of the future that represent very specific environments that can vary a lot from one place to another. Indeed, the indoor environment with a lot of metallic structures and multiple reflectors may lead to severe attenuation, and specific power equipment or machine tools generate impulsive noise. In order to efficiently deploy wireless sensor nodes in factories, there is a crucial need for fast and accurate performance estimation of IoT technologies in this particular context. Based on these results, GRANIT will also explore the possibility to dynamically adapt transmission parameters thanks to reinforcement learning.

GRANIT has a historical expertise on MIMO systems, especially on precoding, whether distributed or not. Precoding aims at using the channel knowledge at the transmitter to adapt the signal to be transmitted to the propagation conditions. Widely used for cellular systems where multiple antennas are embedded on base stations (a.k.a massive MIMO) and mobile devices, precoding can also be used in a distributed and cooperative manner for small IoT nodes, and GRANIT will explore this approach in a security context. A wireless transmission is indeed naturally subject to interception (passive eavesdropping). To circumvent this and increase the secrecy of the transmission, different techniques can be used and can be greatly improved when done in a cooperative manner. In the following years, we will study on how the increasing number of antennas and how the use of precoding/beamforming strategies can improve the secrecy rate of an IoT communication link.

For most of IoT sensor nodes, the communication part is the most energy consuming, and radio activity has therefore to be reduced as much as possible, to avoid idle listening and over-hearing. GRANIT will continue to explore this degree of freedom and propose adaptive MAC protocols for heterogeneous systems with several coexisting standards and technologies. For example, heterogeneous networks can be composed of LPWAN and WLAN nodes, potentially equipped with wake-up receivers, with energy harvesting capabilities. . . As the range and the energy autonomy of all these devices are not the same, there is a crucial need for access protocols that combine all these wireless technologies to reach the best quality of experience as possible.

Indoor positioning Among possible applications of IoT networks, let us emphasize two main topics that GRANIT members want to explore. The first one is indoor localization, useful for industry 4.0, logistics, but also museums, that all require accurate positioning (around 10 cm). In such a stringent requirement, Ultra Wide Band (UWB) based techniques have emerged as accurate solutions. Such radios combine low to medium rate communications with positioning capabilities using ranging techniques. If UWB offers outstanding accuracy, the performance significantly degrades in severe environments (multipath in crowded rooms, impulsive noise in factories). Moreover, to propose energy efficient solutions, a complete cross layer approach has to be envisaged, including hybrid algorithms combining Two Way Ranging (TWR) and Angle of Arrival (AoA) methods, as well as dedicated MAC protocols.

Audio classification The second one relates to audio processing, whether for spatialized sound transmission, in relation with localization explained hereabove, or for context recognition. More and more applications indeed need accurate context recognition to propose adequate services and acoustic sensors appear as very efficient to discriminate environments. The multiplicity of sensors in the same scene obviously enrich the information but transmitting the whole

audio flux is very energy consuming. GRANIT wants to explore the possibility of deporting processing as close as possible to the sensor, which i) decreases the amount of data to be transmitted and ii) allows to guarantee a high level of privacy to users. A particular attention will be paid to the distributed implementation of convolutive neural networks. For spatialized sound transmission, no standard exists yet to transmit high quality spatialized sound with low latency, and GRANIT aims to explore with industrial partners what low power SDR can bring, eventually designing full custom systems.

4 Hardware and Software

4.1 PowWow platform for WSNs

We have proposed and developed PowWow (Power Optimized Hardware and Software Framework for Wireless Motes), a hardware and software platform designed to handle sensor networks and related applications. The main innovating features of the platform are: an energy-efficient MAC protocol (15x less power than the ZigBee standard was reported for equivalent applications), a much more light memory usage, a low-power FPGA for acceleration of part of the software stack (energy reduction of two orders of magnitude was reported for error control and correction) and, more recently, a board including small-scale energy harvesting features, as illustrated on Fig. 5. Our work takes benefit from PowWow to perform power measurements that can be directly introduced in energy consumption models, leading to very precise predictions for the class of preamble sampling MAC protocols. We strongly rely on this platform for the prototyping of future research in this domain.



Figure 5: PowWow WSN Platform with Energy Harvesting

4.2 Energy autonomous LPWAN nodes (AMALO)

The board AMALO (AutonoMous energy hArvesting LOng range) has been made as part of the collaborative project ALAMO with local companies (Europrocess and CG Wireless).

The main aim of this system is to have a platform interfaced with several sensors that can harvest energy and transmit information with a long range radio module. We choose to use the LPWAN LoRa technology mainly because of its flexibility. It can be used in standalone (LoRa) or as part of a standardized protocol (LoRaWAN) with private or public network.

On the block diagram on the left of the Fig. 6, two features can be identified: Energy Harvesting and Processing. Firstly, the Energy Harvesting block is made up of the energy manager chip (SPV1050), the energy source (solar panel, Peltier module, etc.), an energy storage (a super-capacitor and/or a battery) and a chip able to measure the battery current and voltage. Secondly, the Processing block consists of the Murata CMWX1ZZABZ-078 chip and the sensors (with the click-board header and/or the buses header). Click-board header allows us to easily update sensors like temperature, humidity, motion, etc. or add new radio modules and controller. We can see the different elements of the AMALO board on the described board picture (on the right of the Fig. 6).

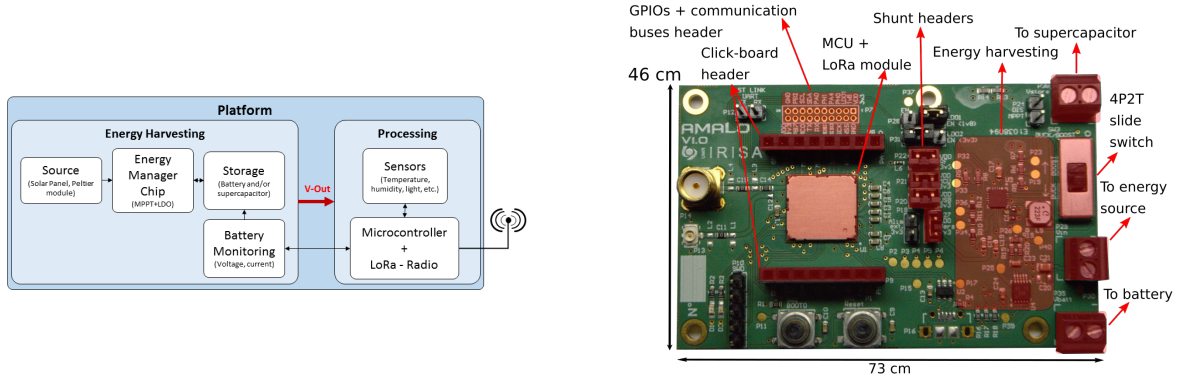

Figure 6: AMALO Block diagram (left) and described board picture (right)

One of the objective of this project was also to define a methodology for sizing energy harvesting components. The proposed methodology must define both energy storage devices (i.e. sizes of battery and capacitor) and harvesting components (i.e. solar panel area) of the AMALO platform. These elements depend on QoS parameters, hardware characteristics and environmental harvesting conditions. The AMALO board and sizing methodology are detailed in [?] in addition to experiments.

4.3 Wireless Body Area Networks (Zyggie)

Zyggie is a motion capture platform design within the labex Cominlabs BoWI project. It consists of a set of electronic components (nodes) arranged on a part or the whole body of a person. The Inertial Measurement Unit (IMU) embedded in these nodes can duplicate the movement on an avatar moving on an Android tablet, as shown by Fig. 7. Communication between nodes is performed by radio and extensive energy optimization allows them an operating autonomy of 20 hours. As recharging nodes batteries also occurs wirelessly, it is therefore possible (even if this is not the case for current prototypes) to embed them in a waterproof box.

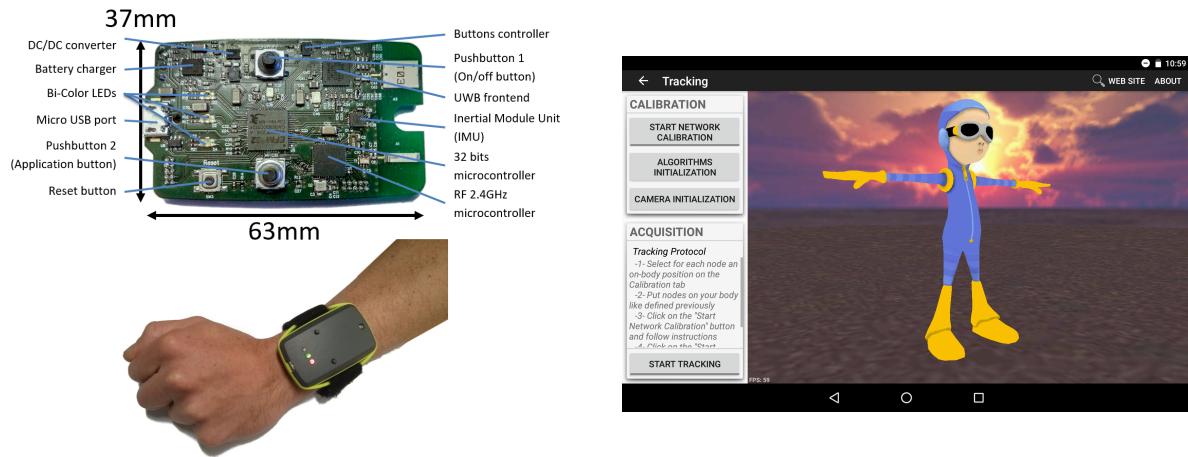

Figure 7: Zyggy V2 and avatar application

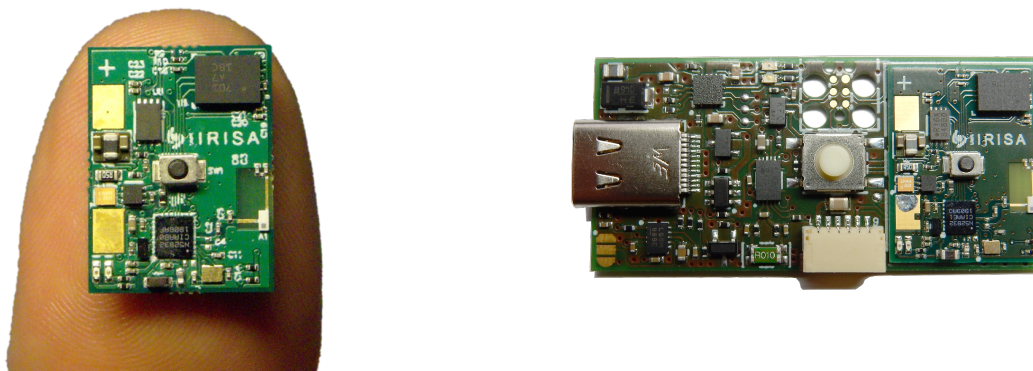

Figure 8: Zyggy Light and its motherboard

This state-of-the-art platform has enabled to thoroughly analyze BAN sensor network related challenges dedicated to motion capture. Our work focused primarily on opportunities to dispense with the energy intensive gyroscope, using radio power information received by the sensor network. The applications are animation, functional rehabilitation, optimization of sports movements, robotics, non-verbal communication in fighting situations.

A new version of this platform was recently designed with high integration constraints as shown by Fig. 8. The system embeds Bluetooth communication, new IMU with high rate data fusion and memory chip to deal with fast motion applications. A motherboard was designed to charge the battery with C-type USB connector and interface other sensors.

4.4 SDR platforms

In the context of SDR paradigm, GRANIT team studies the rapid prototyping of flexible radio waveforms leveraging High Level Synthesis. Both algorithms and architectures are taken into account to target heterogenous (software and hardware) SDR platforms. During the Equipex FIT, GRANIT members have experienced the Nutaq Perseus platform to validate our research by targeting two standards (IEEE 802.15.4 and IEEE 802.11a). We currently use Zynq-based platform from Xilinx to achieve the above mentioned heterogeneity.

The ROSE platform (Software Defined **R**adio Platform for **I**oT heterogeneous embedded systems) has been deployed in 2017. The platform is composed of several USRP-310 devices from Ettus. These SDR belong to the new generation where the architecture is based on both a PS (processing system, here a dual core CPU) and a PL (programmable logic, e.g an FPGA); based on Zynq platform. The SDR platform has been partially funded by the Brittany region (CD22) and by the University of Rennes.

4.5 Real-time FPGA processing for optical access networks

Designed during the ANR FAON project, this platform is a prototype for 1Gbit/s QAM receiver for the optical access networks with Frequency Division Multiplexing (FDM). This prototype is based on a Virtex 7 FPGA and four analog to digital convertors sampling at 1 Gsps. This real-time prototype validates our algorithms for equalization and synchronization, but also a new FPGA design flow based on HLS (High Level Synthesis) and finally, the feasibility of frequency multiplexing for access networks. The prototype has been realized in collaboration with UMR CNRS FOTON for the RF front-end and Orange Labs for the integration in the system and the tests. The GRANIT team has designed the algorithms for demodulation as well as the FPGA implementation.

4.6 FICOP: Foton Irisa Common Optical Platform

To achieve the vision of a distributed, programmable and flexible infrastructure facing the ever growing data volume and the cloudification of services, there is a necessity to investigate, design and experiment transport networks with high bandwidth capacity and agility for smart adaptation to application needs, based on reconfigurable optical systems controlled by software-defined networking (SDN) approaches.

To explore those issues a new optical platform was created between IRISA and Foton laboratories to merge skills of both teams, respectively on digital signal processing and optical communications. This platform was founded with CPER project and allows off-line 30GHz communication link. With 100Gsps Oscilloscope and 88GHz arbitrary waveform generator this equipment is use to design and test new algorithms to enhance next generation optical links.

5 New Results

5.1 Highlights

- M. Gautier and R. Gerzaguet were part of the organizing committee of the annual meeting of GDR SoC² that was held at INSA Rennes in 2021 (June 8-10), as Poster Session Chair and Web chair, respectively.
- The paper "How Can Wake-up Radio Reduce LoRa Downlink Latency for Energy Harvesting Sensor Nodes?" by N. Djidi et al was chosen for the cover of *Sensors* in March 2021.
- In the context of his PhD co-supervised by DGA-MI, C. Lavaud achieved the real-time interception of frequency hopping communications and the recovery of hidden audio content.

5.2 Software Defined Radio

Participants: Robin Gerzaguet, Matthieu Gautier, Romuald Rocher.

Software Defined Radio (SDR) aims to revisit the paradigm of RF architectures. Classic RF architectures are massively integrated, hardware oriented, and can not cope with various bandwidths and carrier frequencies. SDRs are immensely popular as they allow to have a flexible approach for sounding, monitoring, or processing radio signals through the use of generic analog components and lot of digital signal processing. SDRs indeed deport the processing in a software part through the use a general purpose processor (GPP) or digital signal processor (DSP). The processing can be done with the use of high level language such as C++ and Python. This paradigm change allows to use flexible devices that are able to address a wide frequency range (typically from 100MHz to 3-6 GHz) and different services and applications.

As most of the processing is done at software levels (i.e., on a CPU), an efficient software methodology has to be envisioned. Right now, most of the existing methods focus on low-level languages (C or C++) for good runtime performance (at the cost of easy prototyping) or high-level languages (such as Python) for flexibility (at the price of runtime performance). In [6], we propose a new methodology based on Julia language that addresses this two-language problem and paves the way for efficient prototyping without giving up runtime performance. To prove the benefits of the proposed approach, a performance benchmark with several optimization levels compares the Julia approach with C++ and Python [10].

We have initiate a internal Julia organisation (JuliaTelecom) that gathers all the works, packages and ecosytems dedicated to digital communication and software defined Radio in

Julia. This organisation regroups different projects with scholars and engineers outside from Granit; notably from Julia Computing (<https://juliacomputing.com/>)

5.3 Energy Harvesting and Power Manager Design

Participants: Olivier Berder, Matthieu Gautier, Philip Dylan Gleonec, Malo Mabon.

The advent of the Internet of Things has enabled the roll-out of a multitude of Wireless Sensor Networks. Emerging Low Power Wide Area Networks (LPWAN) represent a real breakthrough for monitoring applications, since they give the possibility to generate and transmit data over dozens of kilometers while consuming few energy. Among the LPWAN candidates, LoRa technology and its standardized version LoRaWAN, represent a good trade-off between range, energy consumption and data rate. These networks can be used in various fields, such as agriculture, industry or the smart city, where they facilitate fine optimization of processes. However, the devices are often powered by primary or rechargeable batteries, which limits their battery life. Moreover, it is sometimes not possible or financially viable to change and/or recharge these batteries. A possible solution is to harvest energy from the environment to power these sensors. But these energy sources are unreliable, and the sensor must be able to prevent the complete depletion of its energy storage. In order to adapt its energy consumption, the node can match its quality of service to its energy capabilities. Thus, the device can continuously operate without any service interruption.

If Energy harvesting appears to be a good solution to power these devices, it is not so reliable due to the time-varying nature of most energy sources. It is possible to harvest energy from multiple energy sources to tackle this problem, thus increasing the amount and the consistency of harvested energy, as explained in [4]. Additionally, a power management system can be implemented to compute how much energy can be consumed and to allocate this energy to multiple tasks, thus adapting the device quality of service to its energy capabilities. The goal is to maximize the amount of measured and transmitted data while avoiding power failures as much as possible. For this purpose, an industrial sensor node platform was extended with a multi-source energy-harvesting circuit and programmed with a novel energy-allocation system for multi-task devices. In this paper, a multisource energy-harvesting LoRaWAN node is proposed and optimal energy allocation is proposed when the node runs different sensing tasks. The presented hardware platform was built with off-the-shelf components, and the proposed power management system was implemented on this platform. An experimental validation on a real LoRaWAN network shows that a gain of 51% transmitted messages and 62% executed sensing tasks can be achieved with the multi-source energy-harvesting and power-management system, compared to a single-source system.

5.4 Wake-up radio

Participants: Olivier Berder, Antoine Courtay, Matthieu Gautier, Nour Djidi, Malo Mabon.

Wake-up radio (WuR) have a low sensitivity and thus can misinterpret the received signal inducing a performance degradation of the whole communicating system. To tackle this issue,

low power channel coding techniques can be used and we propose in [8] to apply Hamming coding and Minimum Energy Coding (ME) to enhance WuR range. A performance study of these two types of coding shows that ME coding outperforms Hamming code in reducing both bit error rate and energy consumption. At a range of 28 m, ME coding saves about 3 times the energy at a bit error rate of 10^{-3} compared to uncoded scheme. Furthermore, experimentation on the missed wake-ups when applying ME coding was done, showing a gain of 22% in reliability compared to uncoded scheme.

However, on the WuR side, the latency and energy consumption will increase as the length of the codeword is longer compared to the uncoded symbol. In order to both save energy and reduce the latency, we propose in [3] a novel scheme when receiving the WUB. As the codeword contains one bit at '1' and all the others at '0', we propose to shutdown the ULP-MCU as soon as the first '1' is received (the address information is directly given through the position of the '1'). This novel technique is called Minimum Energy coding Early Shutdown (MEES).

To further improve the WuR reliability and reduce the false wake-up and the missed wake-up while being energy efficient, we also proposed in [7] a preamble filtering. This technique consists in filtering a valid preamble duration by the ULP-MCU before checking the correctness of the address in the WUB. To the best of our knowledge, no previous work proposed to check the validity of the preamble, which is just used to wake up the ULP-MCU of the WuR.

5.5 Heterogenous networks combining Wake-up radio and LoRa

Participants: Olivier Berder, Antoine Courtay, Matthieu Gautier, Nour Djidi.

LoRa is popular for internet of things applications as this communication technology offers both a long range and a low power consumption. However, LoRaWAN has the bottleneck of a high downlink latency to achieve energy efficiency. To overcome this drawback we explore the use of wake-up radio combined with LoRa, and propose an adequate MAC protocol that takes profit of both these heterogeneous and complementary technologies [2]. This protocol allows an opportunistic selection of a cluster head that forwards commands from the gateway to the nodes in the same cluster. Furthermore, to achieve self-sustainability, sensor nodes might include an energy harvesting sub-system, for instance to scavenge energy from the light, and their quality of service can be tuned, according to their available energy. To have an effective self-sustaining LoRa system, we propose a new energy manager that allows less fluctuations of the quality of service between days and nights. Latency and energy are modelled in a hybrid manner, i.e. leveraging microbenchmarks on real hardware platforms, to explore the influence of the energy harvesting conditions on the quality of service of this heterogeneous network. It is clearly demonstrated that the cooperation of nodes within a cluster drastically reduces the latency of LoRa base station commands, e.g. by almost 90% compared to traditional LoRa scheme for a 10 nodes cluster.

5.6 Long range communications performance

Participants: Olivier Berder, Baptiste Vrigneau, Matthieu Gautier, Jules Courjault.

In the last years, LoRa has emerged as a high potential candidate among several standards

for the Internet of Things (IoT) subject to an exponential development. LoRa modulation is based on a classical chirp spread-spectrum technique and permits wireless data transmission up to 50 kbps over several kilometers with a high energy efficiency. Although a well-known principle, its performance in terms of symbol or bit error probability has been theoretically analyzed in few recent papers only. Recently, closed form approximations of Bit Error Probability (BEP) for additive white Gaussian noise channels and Rayleigh fading channels were proposed. We proposed in [1] a new approach based on Marcum function to estimate in a fast and accurate manner the performance in terms of Bit Error Rate of LoRa. The method is proposed for Gaussian channels, over challenging propagation environments, i.e., Ricean and Nakagami fading. Simulation results show that our proposed approximation reduces the approximation error about one order of magnitude compared to existing ones and can be computed by classical software.

5.7 Indoor Localization

Participants: Olivier Berder, Arnaud Carer, Antoine Courtay, Mickaël Le Gentil, Pascal Scalart.

Knowing the position of a device in its environment becomes an important issue for applications providing services based on the position. Many solutions have been proposed going from satellite-based techniques (i.e. GPS...), video tracking or radio-electrical waves combining... However, these techniques reach their limit when very high accuracy is required (lower than 10 cm), especially in indoor environment. In such a stringent requirement, Ultra Wide Band based techniques have emerged as accurate solutions. UWB systems represent promising solutions for Factory of the Future, to help industry manage the different flows of good or persons. Orange Labs, Prolann, Axalon and GRANIT are associated to explore UWB positioning performance in such a context in the Mo.Di.Flu project (AAP PME I&R, 2019-2021). Industry 4.0 is indeed considered by Orange Labs as a key target for offering new localization-based services for factories. In the Mo.Di.Flu project a new wired synchronized UWB platform is developed by 3D Ouest in which we will embed our low power localization algorithms.

5.8 Radio-Frequency security

Participants: Olivier Berder, Robin Gerzaguet, Matthieu Gautier, Corentin Lavaud.

While operating, information processing devices or communication systems may emit unwanted signals (or alter existing ones) through electromagnetic waves, light, sound or power drain. These side-channels can be intercepted by anyone with scientific or technical knowledge and appropriate equipment, leading to a potentially high risk of security breaches. This survey focuses on these emanation side-channels and provides an extensive literature review. To provide an in-depth analysis despite the variety of attacks, we propose in [5] to classify the sidechannels based on their criticality, their intentionality, the type of attackers, and the physical medium. Illustrative use-cases are presented and serve as a basis to infer individual threats. Particular attention is paid to electromagnetic side-channels which exhibit the highest criticality and have therefore been used in the most recent attacks. The main characteristics

of the sidechannels revealed by state-of-the-art papers are summarized and recommendations on countermeasures are provided to protect any sensitive equipment.

5.9 Optical Communications

Participants: Robin Gerzaguet, Pascal Scalart.

The PhD thesis of Marwa Kazdoglhi Lagha on the design of optical impairments compensation has been successfully defended in June 2021. The originality of the proposed work lie in the research of low complexity solutions, yet able to cope with the harsh constraints of flexible optical networks and the fact the proposed algorithms should be independent from the modulation format.

We have focused our work on digital signal processing techniques used in the coherent optical communication systems for high speed and flexible optical transmissions. Three different algorithms have been proposed. The "joint" algorithm performs the polarization demultiplexing and IQ imbalance compensation. Two other carrier phase noise recovery algorithms called "MDD-CPR" and "R- BPS" were introduced. "Joint" approach performs well in the flexible context. Its robustness to other distortions (polarization dependent losses, dynamic multiplexing) has been demonstrated with less complexity compared to classic "CMA + BASS" approach and it was validated experimentally on real data. On the other hand, "MDD-CPR" is a modified version of the classic decision-directed algorithm whose performance in simulation and with real signals has been tested. Advantageous characteristics of its S-curve compared to the conventional approach and its robustness against phase noise underline its interest. "R-BPS" allows laser phase noise recovery with a minimum number of test phases. Numerical and experimental parallel processing have demonstrated its ability to operate better than "BPS" with lower overall complexity.

5.10 Energy Optimization in wireless networks

Participants: Marie-Anne Lacroix, Romuald Rocher, Pascal Scalart.

We address the problem of the optimal M-QAM order in a realistic energy model [9]. Our researches focus on the power amplifier (PA) equation, which depends on transmission power, drain efficiency and peak-to-average ratio. These last two elements are never used together in the hardware parameters, especially those related to the digital analog converter. This study shows that drain efficiency and PAR can have a crucial importance in the estimation of the system energy consumption and the choice of the optimal modulation order. Furthermore, in traditional optimization studies, the maximal PA power is always neglected. However, in function of PA power allowed by the transceiver and the communication channel conditions, the modulation order might be revised to prevent quality of service loss.

6 Contracts and Grants with Industry

6.1 CIFRE PhD Grant Prolann/seismowave

Participants: Olivier Berder, Antoine Courtay, Samir-Sharif El Rhaz.

This is a Cifre contract with Prolann/SeismoWave company that includes the supervision of Samir-Sharif El Rhaz.

During the last few years, infrasound sensors have been getting an increased interest, due to their ability to provide a near real-time and continuous monitoring of natural hazards (e.g. climate-related phenomena, detection of seismic event like earthquakes or unusual volcano activity), but also the potential to survey and control comprehensive nuclear Test Ban Treaty over long time periods.

Prolann/SeismoWave is one of the major companies in this field and offers a wide range of infrasound and seismic sensors, some of them based on common patents with CEA. However, energy consumption of current infrasound systems is very high and their deployment and maintenance very heavy.

The goal of this thesis is to propose energy autonomous infrasound devices. To tackle this challenge, power management strategies will be proposed while considering long range communications within the sensor network. The device will be as generic as possible to support different QoS and energy harvesting conditions.

6.2 Eco-counter

Participants: Antoine Courtay, Olivier Berder, Mickaël Le Gentil, Malo Mabon, Clément Caresmel.

Eco-Counter has been developing various sensors for many years to assess attendance in areas of interest such as natural parks. The compactness of the sensors and their energy autonomy are currently the two major issues in the design of the new family of sensors. To be able to make the sensor itself as discrete as possible, Eco-Counter would in particular like to study the possibility of separating the latter from the counter part (more imposing and consuming in energy).

Since the distance between these two entities can reach several meters, it is necessary to study the various state-of-the-art technologies that are able to communicate reliably and at low energy cost on this scope. Given the strong energy constraints on the sensor side, wired bus technologies will of course be discussed first. The study will then focus on the possibility of communicating by radio between the entities while maintaining correct energy consumption.

7 Other Grants and Activities

7.1 National Collaborations

- **ANR Labex CominLabs - NOP (2021-2024)**

Participants: Matthieu Gautier, Olivier Berder, Robin Gerzaguet

Intermittent computing is an emerging paradigm for batteryless IoT nodes powered by

harvesting ambient energy. It intends to provide transparent support for power losses so that complex computations can be distributed over several power cycles. NOP aims at improving the efficiency and usability of intermittent computing, based on consolidated theoretical foundations and a detailed understanding of energy flows within systems. For this, it brings together specialists in system architecture, energy-harvesting IoT systems, compilation, and real-time computing. NOP consortium is composed of IRISA (Granit team), IETR (SysCom) team, INRIA (PACAP team) and LS2N (SRC team). Within this project, our GRANIT team will develop both hardware and software parts of the platform.

- **ANR PRCE - U-Wake (2021-2024)**

Participants: Matthieu Gautier, Olivier Berder

ANR U-Wake project aims to achieve a breakthrough in the field of IoT by developing a disruptive wake-up receiver solution based on (1) a bioinspired architecture achieved with an industrial CMOS technology (with transistors operating in deep sub-threshold regime) and (2) Electro Magnetic energy harvesting. The originality lies in the association of a Radio Frequency (RF) demodulator to a neuro-inspired detector and dataprocessing through a spiking neural network (SNN), resulting in a complete ultra-low power wake-up radio supplied with a voltage of a few 100 mV. The U-Wake consortium is composed of very complementary laboratories in computer science and electrical engineering domains, namely IRISA, IEMN (Lille) and CITI (Lyon). Within this project, our GRANIT team will be in charge of the implementation of the prototype design. In collaboration with IEMN, it will embed the bioinspired IC in a new type of wake-up receiver and with CITI the energy harvester.

- **ANR PRCE - Wake-Up (2017-2021)**

Participants: Olivier Berder, Antoine Courtay, Matthieu Gautier

Using pure-asynchronous communication allowed by emerging Ultra-Low-Power (ULP) wake-up receivers (WUR), Wake-Up aims at proposing a low latency and energy efficient network architecture composed of heterogeneous radio nodes (long-range communication and ULP short-range WUR) with dedicated access and network protocols. A two-way cross layer optimization is envisaged in Wake-Up, since on one hand these heterogeneous network higher layers will take into account the specificities of the wake-up radio to optimize energy and latency, and on the other hand some recurrent application constraints will lead to specific wake-up radio designs. The consortium is composed of two academic partners (University of Rennes 1 and University of Strasbourg), one state-owned industrial and commercial establishment (CEA LETI) and one SME (Wi6Labs). The consortium will address these scientific challenges at both the node and the network levels, with controlled (FIT IoT Lab) and real-field experimental validations.

- **AMI ADEME Goodflow (2021-2023)**

Participants: Olivier Berder, Matthieu Gautier, Malo Mabon, Nour el hoda Djidi

GoodFlow offers a solution that automates the monitoring and management of reusable industrial packaging (tertiary packaging), consisting of an IoT to put in each packaging

and a web and mobile application. The lack of genericity/reliability of current geolocation systems makes impossible to automate inventories, since it can not be proved who is responsible for industrial packaging in real time.

GoodFlow therefore wants to design an on-board system making it possible to provide concrete proof of the site responsible for each packaging 24 hours a day, 7 days a week, without human intervention, without infrastructure, and with IoTs having a lifespan equal to those of the packaging (7 to 10 years). To achieve this, the GoodFlow project aims to integrate the following technologies on a suitable electronic card: on-board AI fed by an accelerometer to wake-up the node on particular events, a wake-up radio to discover the neighborhood while consuming quasi nothing, and a multi-radio MAC layer to connect surrounding radio networks and definitely attest the positioning (and eventually the responsible) of the packaging.

Goodflow leverages a well-balanced consortium composed of an SME (Goodflow) and 4 laboratories (Lab-STICC, INRIA Lille, IEMN and IRISA).

- **Images & Réseaux Competitivity Cluster - HAD-OC (2018-2021)**

Participants: Robin Gerzaguet, Antoine Courtay, Olivier Berder, Mickaël Le Gentil

The development of immersive technologies (augmented reality, virtual reality) offers an important opportunity in the audio field. Sound represents 50% of the immersion quality and is therefore a key factor in the user experience. However, technologies for the transmission and the processing of audio data have not evolved as fast as the virtual reality ones did. The HAD-OC project aims at developing a wireless audio transmission solution compatible with 3D professional sound requirements. The bit rate will be at least 4.6 Mbps and the latency less than one millisecond. To meet the needs of 3D sound and virtual reality, the system will allow 3D geolocation of transmitters / receivers. We will demonstrate in the project point-to-point transmission and broadcast transmission. To do so, Feichter Electronics, 3D Ouest and the Granit team will join forces to develop a method for wireless transmission of a high quality digital audio signal without latency.

- **Images & Réseaux Competitivity Cluster - Modiflu (2019-2022)**

Participants: Antoine Courtay, Olivier Berder, Mickaël Le Gentil

Collecting production data, analyzing data flows and providing a unique interface based on factory digital model should bring productivity gains to factories. Thanks to sensor disseminated in the factory and non-structured data (e.g. e-mails), the Modiflu project aims to significantly reduce the on-time delivery indicator of Prolann, that will serve as experimentation field. Axalon is in charge of the digital twin, while Orange Labs will provide its capabilities of data mining and user-centric interfaces. GRANIT is in charge of the indoor localization system, based on UWB communications. As the factory environment is subject to severe degradation, robust localization and communication protocols have to be imagined.

- **Images & Réseaux Competitivity Cluster - HIJ (2020-2022)**

Participants: Olivier Berder, Matthieu Gautier, Malo Mabon, Mickaël Le Gentil

The project consists in developing a tracker connected to a LoRa network, leveraging a configurable embedded OS (Operating System) and an energy harvesting system. The main axis of innovation of this tracker are the design of a very constrained energy manager and the use of an OS to create and compile the embedded code using a web interface simplified ('safe & secure by design'), in order to accelerate the integration of the following firmware functionalities: improved quality of service of the LoRa network, secure data transmission, optimized accuracy of geolocation. The leader of HIJ project is ERCOGENER, and the consortium is completed by the SME TICATAG.

8 Dissemination

8.1 Scientific Responsibilities

- O. Berder is a member of the Editorial Board of *International Journal of Distributed Sensor Networks*
- O. Berder is a member of the Editorial Board of *Wireless Communications and Mobile Computing*
- O. Berder is a member of the Editorial Board of *Sensors*
- O. Berder is a member of Technical Program Committee of IEEE PIMRC, IEEE SAS, ACM EWSN, ICT and is a reviewer for IEEE TSP, TWC, ToN, JSAC, ICC, GLOBECOM...
- O. Berder is a member of Labelling Committee (CSV) of Images & Networks cluster
- O. Berder served as a reviewer and president of the committee for the HDR defense of Valentin Gies, *Toward ultra-low power embedded artificial intelligence*, defended at University of Toulon, November 25 2021
- O. Berder served as a reviewer for the PhD of Rida Khan, *System Level Optimizations in Wearable Wireless Networks*, defended at Tallinn University of Technology, Estonia, February 26 2021
- O. Berder served as a reviewer for the PhD of Sebastian Sampayo, *Polymorphic network protocol suite in heterogeneous wake-up IoT networks*, defended at Université de Strasbourg, March 17 2021
- O. Berder served as the president of the committee for the PhD defense of Sebastian Marzetti, *Apprentissage et supervision dans les systèmes embarqués ultra low power*, defended at Université de Toulon, November 22 2021

- O. Berder served as a reviewer for the PhD of Sota Sawaguchi, *Gestion adaptive de l'alimentation des objets connectés limités en ressources*, defended at Université de Grenoble Alpes, November 17 2021
- O. Berder served as a reviewer for the PhD of Wahiba Abid, *Récepteurs MIMO massif à complexité réduite en présence d'interférences*, defended at Université de Sherbrooke, Canada, March 5 2021
- A. Courtay served as a reviewer for IJDSN, ISCAS, SAS, ADHOC.
- M. Gautier served as an examiner for the PhD of Anima Nahali, *Propagation Channel Modeling for Wireless Body Area Networks*, defended at University of Sousse, Tunisia, December 29 2021
- M. Gautier was a member of technical program committee of DICES-N workshop, IEEE ISWCS, ICT, IEEE WCNC, IEEE PIMRC and IEEE Globecom.
- B. Vrigneau served as a reviewer for IEEE Communications Letters, PIMRC, ISTC, WCMC, MDPI Sensors, IEEE Trans. on Vehicular Technology, Grets.
- B. Vrigneau was a member of technical program committee of IEEE PIMRC and 4th International Workshop on Non-Intrusive Load Monitoring.
- Robin Gerzaguet served as a reviewer for GRETSI, IEEE EUCNC, IEEE WCNC, IEEE Access and IEEE Transaction on Wireless Communications.

8.2 Involvement in the Scientific Community

- O. Berder did a presentation entitled "Zyggie et Zyggie Light : plateformes de capteurs pour localisation intérieure et monitoring sportif" during the "Journée commune Capteurs, GDR SoC2 et GDR Sport", INSEP, November 19 2021
- O. Berder and B. Vrigneau are members of scientific committee of IUT Lannion.
- O. Berder is part of the Scientific Committee of EUR Digisport.
- M. Gautier is an organizer of Architecture and algorithms Topic at GDR ISIS.

8.3 Teaching Responsibilities

IUT stands for *Institut Universitaire de Technologie* and ENSSAT stands for *École Nationale Supérieure des Sciences Appliquées et de Technologie* and is an *école d'Ingénieurs*. Both are located in Lannion and part of the University of Rennes 1.

- P. Scalart is the Head of the Electronics Engineering department of ENSSAT.
- A. Courtay is supervising the first year students of the Electronics Engineering department of ENSSAT.

- M. Gautier is the Head of the Network and Telecommunications Department at IUT Lannion.
- M. Gautier is member of the French National University Council since 2015 in signal processing and electronics (Conseil National des Universités en 61e section) - elected again in 2019.
- O. Berder is in charge of Studies Pursuit of Physical Measurements Department at IUT Lannion.
- O. Berder and B. Vrigneau are elected members of IUT Institute Council and Direction Committee.
- B. Vrigneau is the Head of the new department Multimedia and Internet at IUT Lannion.

8.4 Teaching

- O. Berder: signal processing, 70h, IUT Lannion (L2)
- O. Berder: sensors and control, 90h, IUT Lannion (L2) and 25h, UFAZ Bakou, Azerbaijan (L2)
- O. Berder: digital systems, 80h, IUT Lannion (L1)
- O. Berder: IoT and connected objects, 14h, ENSSAT (L3 and M2)
- A. Courtay: digital electronics, 122h, ENSSAT (L3)
- A. Courtay: digital system design, 12h, ENSSAT (L3)
- A. Courtay: PCB conception, 14h, ENSSAT (L3)
- A. Courtay: digital electronics communication interfaces, 68h, ENSSAT (M1)
- A. Courtay: digital electronics: Laser diode driver, 16h, ENSSAT (M1)
- M. Gautier: computer architecture, 36h, IUT Lannion (L1)
- M. Gautier: telecommunications, 138h, IUT Lannion (L1)
- M. Gautier: digital communications, 30h, IUT Lannion (L2)
- M. Gautier: IoT and connected objects, 10h, ENSSAT (L3)
- R. Rocher: electronics, 44h, IUT Lannion (L1)
- R. Rocher: telecommunications, 82h, IUT Lannion (L1)
- R. Rocher: signal processing, 12h, IUT Lannion (L2)
- R. Rocher: digital communications, 48h, IUT Lannion (L2)

- P. Scalart: non-linear optimisation, 18h, Master by Research (SISEA) and ENSSAT (M2)
- P. Scalart: parametric modelization, optimal and adaptive filters, 24h, Master by Research (SISEA) and ENSSAT (M2)
- P. Scalart: source coding, 14h, Master by Research (SISEA) and ENSSAT (M2)
- P. Scalart: cellular networks, 24h, ENSSAT (M2)
- P. Scalart: digital communication systems, 32h, ENSSAT (M1)
- P. Scalart: random signals and systems, 12h, ENSSAT (M1)
- R. Gerzaguet: Micro-electronics, 46h, ENSSAT (L3)
- R. Gerzaguet: Digital Signal processing, 60h, ENSSAT (M1)
- R. Gerzaguet: Wireless network, 9h, ENSSAT (M1)
- R. Gerzaguet: Wireless communication, 20h, ENSSAT (M2)
- R. Gerzaguet: System On Chips, 22h, ENSSAT (M2)
- B. Vrigneau: computer architecture, 14h, IUT Lannion (L1)
- B. Vrigneau: enterprise telephony, 20h, IUT Lannion (L1)
- B. Vrigneau: maths, 24h, IUT Lannion (L2)
- B. Vrigneau: telecommunications, 190h, IUT Lannion (L1, L2, L3)

9 Bibliography

Articles in referred journals and book chapters

- [1] J. COURJAULT, B. VRIGNEAU, O. BERDER, M. R. BHATNAGAR, “A Computable Form for LoRa Performance Estimation: Application to Ricean and Nakagami Fading”, *IEEE Access* 9, 2021, p. 81601 – 81611, <https://hal.inria.fr/hal-03473400>.
- [2] N. E. H. DJIDI, M. GAUTIER, A. COURTAY, O. BERDER, M. MAGNO, “How Can Wake-up Radio Reduce LoRa Downlink Latency for Energy Harvesting Sensor Nodes?”, *Sensors* 21, 3, January 2021, p. 733, <https://hal.inria.fr/hal-03122603>.
- [3] N. EL HODA DJIDI, M. GAUTIER, A. COURTAY, O. BERDER, “MEES-WuR: Minimum Energy Coding with Early Shutdown for Wake-up Receivers”, *IEEE Transactions on Green Communications and Networking*, May 2021, <https://hal.inria.fr/hal-03223796>.
- [4] P.-D. GLEONEC, J. ARDOUIN, M. GAUTIER, O. BERDER, “Energy Allocation for LoRaWAN Nodes with Multi-Source Energy Harvesting”, *Sensors* 21, 8, April 2021, <https://hal.inria.fr/hal-03206750>.

- [5] C. LAVAUD, R. GERZAGUET, M. GAUTIER, O. BERDER, E. NOGUES, S. MOLTON, “Whispering devices: A survey on how side-channels lead to compromised information”, *Journal Hardware and Systems Security*, March 2021, <https://hal.archives-ouvertes.fr/hal-03176249>.
- [6] C. LAVAUD, R. GERZAGUET, M. GAUTIER, O. BERDER, “AbstractSDRs: Bring down the two-language barrier with Julia Language for efficient SDR prototyping”, *IEEE Embedded Systems Letters*, January 2021, p. 1–1, <https://hal.archives-ouvertes.fr/hal-03122623>.

Publications in Conferences and Workshops

- [7] N. E. H. DJIDI, M. GAUTIER, A. COURTAY, O. BERDER, “Enhancing Wake-Up Receivers Reliability Through Preamble Filtering and Minimum Energy Coding”, in: *IEEE International Symposium on Circuits and Systems (ISCAS)*, Daegu, South Korea, May 2021, <https://hal.inria.fr/hal-03216281>.
- [8] N. EL HODA DJIDI, M. GAUTIER, A. COURTAY, O. BERDER, “Enhancing Wake-Up Radio Range Through Minimum Energy Coding”, in: *ICC 2021 - IEEE International Conference on Communications*, Montreal / Virtual, Canada, June 2021, <https://hal.inria.fr/hal-03279903>.
- [9] M.-A. LACROIX, R. ROCHER, P. SCALART, “Realistic power amplifier model for energy optimization in wireless networks”, in: *2021 17th International Symposium on Wireless Communication Systems (ISWCS)*, IEEE, p. 1–4, Berlin, Germany, September 2021, <https://hal.inria.fr/hal-03481983>.
- [10] C. LAVAUD, R. GERZAGUET, M. GAUTIER, O. BERDER, “Prototypage de radio logicielle à base du langage Julia”, in: *15ème Colloque National du GDR SOC2*, Rennes, France, June 2021, <https://hal.archives-ouvertes.fr/hal-03473423>.